

E2 3D Printer

Quick Start Guide

* Please review this entire guide before operating the printer.

WARNING

This is a class A product. In a domestic environment this product may cause radio interference in which case the user may be required to take adequate measures.

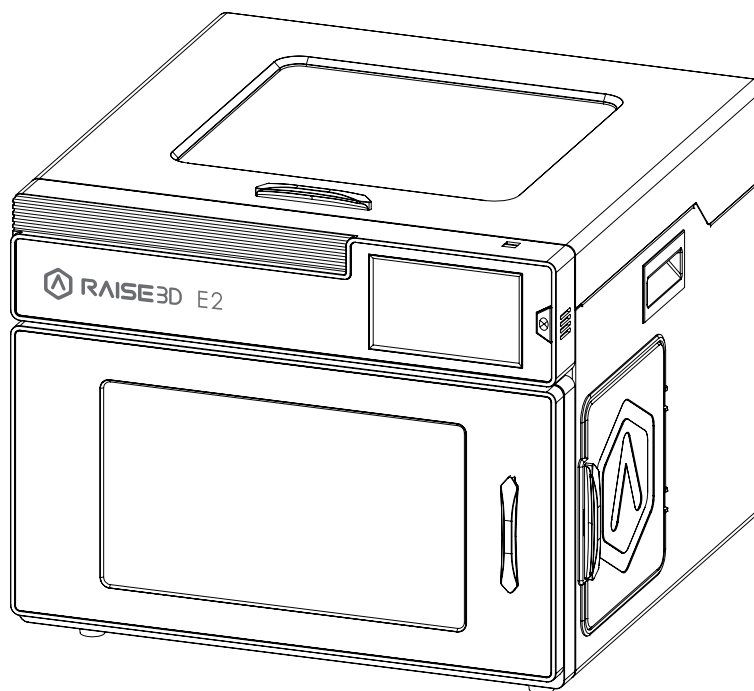

CONTENTS

Safety.....	1
Electromagnetic Compatibility - EMC.....	2
Technical Specifications	4
Printer Components and Parts.....	6
Raise3D Supplies and Accessories.....	10
Precaution and Hardware Installation.....	11
Software Installation.....	13
WLAN Connection.....	20
Maintenance.....	21
Start Printing.....	23
User Interface	24
Experiencing Difficulties/Contact Information	25

Safety



Warning: Indicates a potentially hazardous situation which, if not avoided, may result in injury or damage.



Hot Nozzle: The hot nozzle sign indicates the presence of devices with high temperatures. Always use extra care when working around heated components. Always wear the heat resistant gloves provided in the Starter Box when working near the nozzle.

Nozzle temperatures in the printer can reach 300°C(572°F).



Hot Surface: The hot surface sign indicates the presence of devices with high temperatures. Always use extra care when working around heated components. Always wear the heat resistant gloves provided in the Starter Box when working near hot surfaces.



Moving Parts: The moving parts sign indicates that a hazard exists. If touched, it can cause serious bodily injury. Always keeps hands clear of moving parts.



High Voltage: The high voltage sign indicates the presence of high voltages. Always stay away from exposed circuitry. It is recommended that all conductors be removed.

Electromagnetic Compatibility - EMC

- **Simplified EU Declaration of Conformity**

Raise3D declares that this device is in compliance with the essential requirements and other relevant provisions of Directive 2014/53/EU. Full text of the EU declaration of conformity is available at <https://www.raise3d.com>.

CE Mark Warning

This is a Class B product, in a domestic environment, may cause radio interference, in which case the user may be required to take adequate measures.



AT	BE	BG	CZ	DK	EE	FR
DE	IS	IE	IT	EL	ES	CY
LV	LI	LT	LU	HU	MT	NL
NO	PL	PT	RO	SI	SK	TR
FI	SE	CH	UK	HR		

CE Output power table:

Function	Frequency	Maximum Output Power (EIRP)
Wi-Fi	2412-2472 MHz	18 dBm(b)/ 18 dBm (g)/ 13 dBm (HT)
	5150-5250 MHz	19 dBm(a)/ 18.5 dBm(HT20)/ 17.5 dBm(HT40)
	5725-5850 MHz	14 dBm(a)/ 14 dBm(HT20)/ 14 dBm(HT40)

FCC Output power table:

Function	Frequency	Maximum Output Power (EIRP)
Wi-Fi	2412-2462 MHz	18.31dBm(b)/ 15.62dBm (g)/ 14.9 dBm (HT 20)
	5150-5250 MHz	15.36 dBm(a)/ 14.79 dBm(HT20)/ 14.41 dBm(HT40)
	5725-5850 MHz	15.48 dBm(a)/ 14.49 dBm(HT20)/ 14.06 dBm(HT40)

● **FCC Statement**

This device and its antenna must not be located or operated in conjunction with any other antenna and transmitter.

This device complies with part 15 of the FCC rules. Operation is subject to the following two conditions: (1) this device may not cause harmful interference, and (2) this device must accept any interference received, including interference that may cause undesired operation.

NOTE: The manufacturer is not responsible for any radio or TV interference caused by unauthorized modifications to this equipment. Such modifications could void the user's authority to operate the equipment.

NOTE: This equipment has been tested and certified to comply with the limits of a Class B digital device, pursuant to part 15 of the FCC Rules. These limits are designed to provide reasonable protection against harmful interference in a residential installation. This equipment generates uses and can radiate radio frequency energy and, if not installed and used in accordance with the instructions, may cause harmful interference to radio communications. However, there is no guarantee that interference will not occur to a particular installation. If this equipment does cause harmful interference to radio or television reception, which can be determined by turning the equipment off and on, the user is encouraged to try to correct the interference by one or more of the following measures:

- Reorient or relocate the receiving antenna.
- Increase the separation between the equipment and receiver.
- Connect the equipment into an outlet on a circuit different from that to which the receiver is connected.

RF exposure information: This equipment complies with FCC radiation exposure limits set forth for an uncontrolled environment. This equipment should be installed and operated at a minimum distance of 20cm between the radiator and your body.

Changes or modifications not expressly approved by the party responsible for compliance could void the user's authority to operate the equipment.

Technical Specifications

ITEM	E2	
CONSTRUCTION	Build Volume (WxDxH)	
	Single Extruder Print	Dual Extruder Print
	13.0x9.4x9.4 inch /330x240x240 mm	11.6x9.4x9.4 inch / 295x240x240 mm
	Machine Size (WxDxH)	
	23.9x23.5x18.3 inch / 607x596x465 mm	
ELECTRICAL	Power Supply Input	100-240 V AC, 50/60 Hz 230 V @2A
	Power Supply Output	24 V DC, 350 W
PRINTER	Print Technology	FFF
	Print Head	Independent Dual Extruders
	Filament Diameter	1.75 mm
	XYZ Step Size	0.78125, 0.78125, 0.078125 micron
	Print Head Travel Speed	30 - 150 mm/s
	Build Plate	Flexible Steel Plate with Buildtak
	Max Build Plate Temperature	110 °C
	Heated Bed Material	Silicone
	Build Plate Leveling	Mesh-leveling with Flatness Detection
	Supported Materials	PLA/ ABS/ HIPS/ PC/ TPU/ TPE/ NYLON/ PETG/ ASA/ PP/ PVA/ Glass Fiber Infused/ Carbon Fiber Infused/ Metal Fill/ Wood Fill
	Nozzle Diameter	0.4 mm (Default), 0.2/ 0.6/ 0.8/ 1.0 mm (Available)
	Hotend	V3P (V3 hotend with PTFE version)
	Max Nozzle Temperature	300 °C
	Connectivity	Wi-Fi, LAN, USB port, Live camera
	Noise Emission (Acoustic)	< 50 dB(A) when building
	Operating Ambient Temperature	15 - 30 °C, 10 - 90% RH non-condensing
	Storage Temperature	-25 to 55 °C, 10 - 90% RH non-condensing
	Technical Certifications	CB, CE, FCC, RoHS, RCM
	Filter	HEPA filter with activated charcoal
SOFTWARE	Slicing Software	ideaMaker
	Supported File Types	STL/ OBJ/ 3MF
	Supported OS	Windows/ macOS/ Linux
	Machine Code Type	GCODE
PRINTER CONTROLLER	User Interface	7-inch Touch Screen
	Network	Wi-Fi, Ethernet
	Resume Print after Power Outage	Firmware recording, no need for battery installation
	Screen Resolution	1024x600
	Motion Controller	Atmel ARM Cortex-M4 120MHz FPU
	Logic Controller	NXP ARM Cortex-A9 Quad 1 GHz
	Memory	1 GB
	Onboard Flash	8 GB
	OS	Embedded Linux
	Ports	USB2.0x2, Ethernetx1

The firmware is based on RepRapFirmware (<https://github.com/dc42/RepRapFirmware>)

The electronics inspired by Duet3D.

DUET 2 WIFI and DUET 2 ETHERNET LICENSE

The Duet WIFI/ DUET 2 WIFI and DUET ETHERNET are licensed under the terms of the CERL OHL 1.2 (see below or http://www.ohwr.org/attachments/2388/cern_ohl_v_1_2.txt for full text) will the following additional conditions:

a. Attribution:

Any reproductions or modifications of the hardware must contain the following attribution on the silkscreen and packaging:

"Based on the DuetWifi by Think3dPrint3d and Escher3d, see www.duet3d.com for the original DuetWifi information. This reproduction/modification is not endorsed or supported in any way by Think3dPrint3d or Escher3d".

b. Logos:

No reproduction or modification of the Duet 2 Wifi or Ethernet hardware may contain the Think3dPrint3d, Escher3d or Duet3d logos.

Should you need any further information, please do not hesitate to email us at inquiry@raise3d.com.

Printer Components and Parts

1. Front Parts

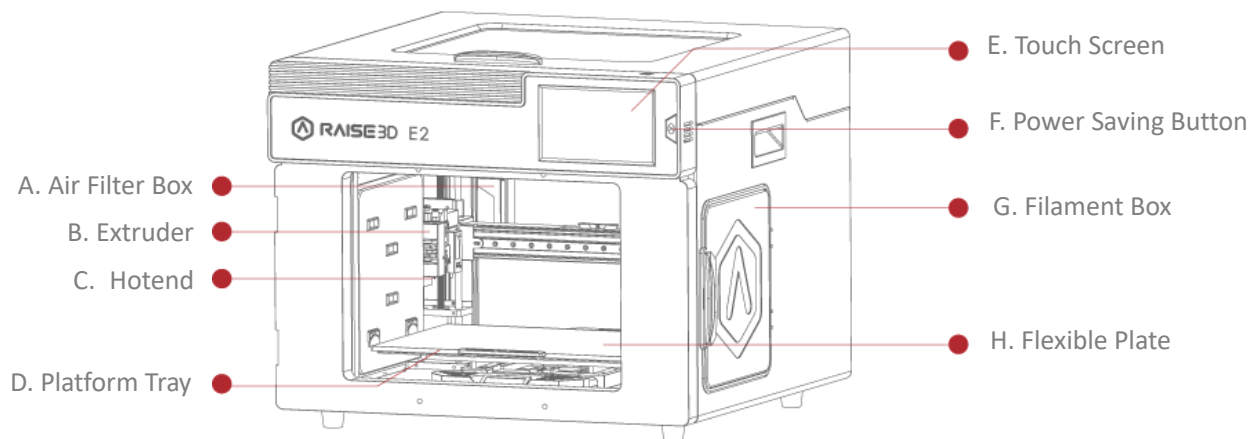

A. Air Filter Box

Contains the air filter, which can filter out part of the harmful gas produced in the printing process.

B. Extruder

Feeds the filament into the hotend.

C. Hotend

The hotend consists of a nozzle, heater block, thermocoupler, heater rod, throat tube, and heat sink.

D. Platform Tray

The Platform Tray is highly magnetized to ensure that the build plate stays in place.

E. Touch Screen

On-board computing system to display printer status, error messages, and receive commands.

F. Power Saving Button

Quick press to put the screen and LED in sleep/wake mode; Long press for 10 seconds to restart.

G. Filament Box

Holds the filament that will be printed.

H. Flexible Plate

You can easily remove your models after they've finished printing by bending the plate.

2. Back Parts

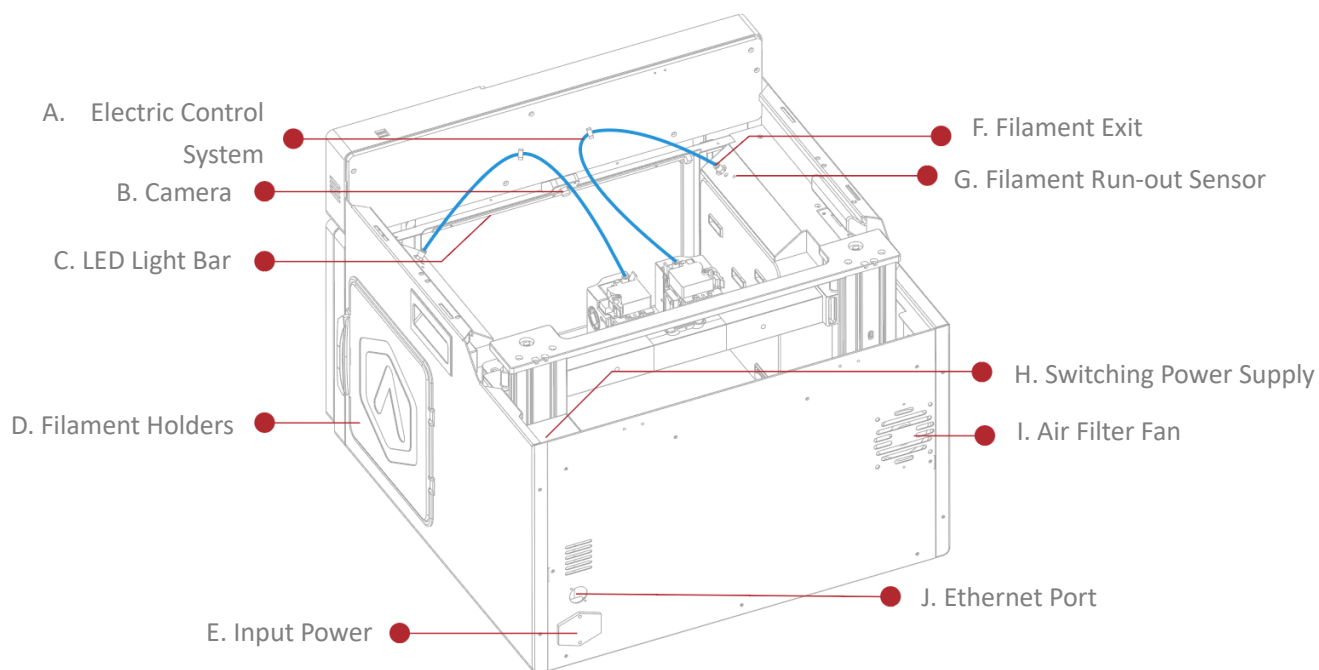

A. Electric Control System

Includes screen components and the motion control panel. Do not open without permission.

B. Camera

Used to observe the operation of the printer.

C. LED Light Bar

Provides interior lighting of the chassis.

D. Filament Holder

Holds the filament spool, maximum weight 3 kg.

E. Input Power

AC input and switching.

F. Filament Exit

The filament leads from here to the extruder.

G. Filament Run-out Sensor

Detects when the material has run out.

H. Switching Power Supply

Switches from alternating current to direct current. Please be careful, it's dangerous! Do not remove the power box without permission.

I. Air Filter Fan

Pulls air out of the machine through the air filter.

J. Ethernet Port

RJ45 port to connect the printer to a network.

3. Other Parts

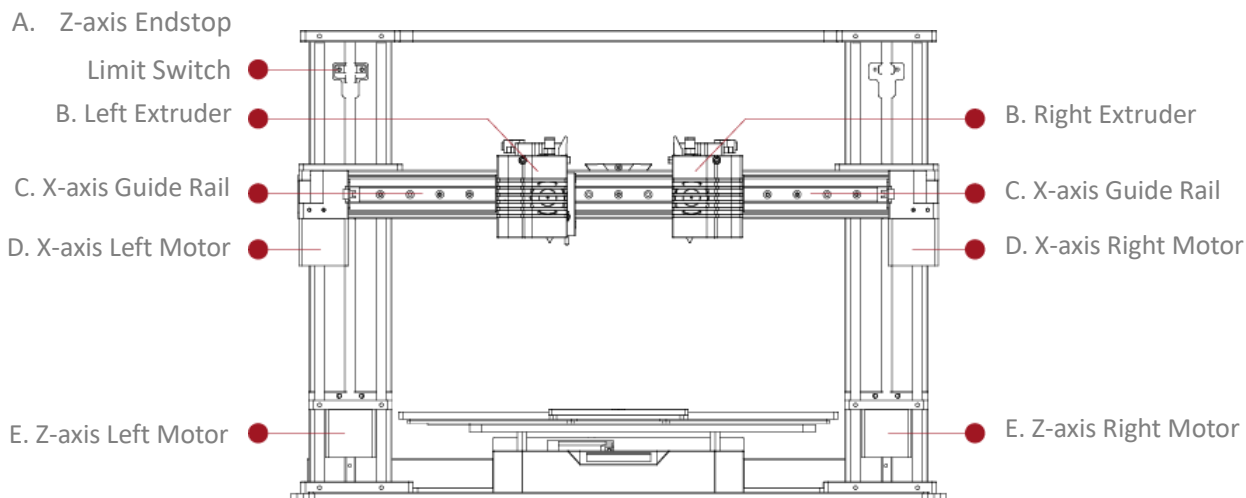

- A. Z-axis Endstop Limit Switch
Limits the maximum position in the Z direction and provides a Z-axis zero reference.
- B. Extruder (Left/Right)
Feeds the filament into the hotend.
- C. X-axis Guide Rail
Guides the extruder’s movement along the X-axis.
- D. X-axis Motor (Left/Right)
Respectively controls the corresponding extruder for horizontal movement.
- E. Z-axis Motor (Left/Right)
Controls both ends of the X-axis beam for synchronous lifting movements.

Raise3D Supplies and Accessories

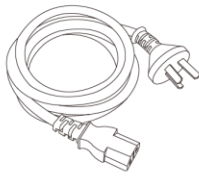

Power Cable
(x5)

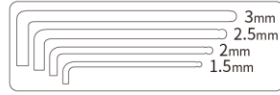

Hex Wrenches

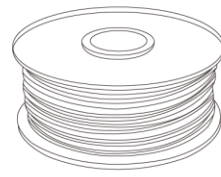

Filament
(x2)



Tweezers



Heat Resistant Gloves



Spatula



Filament
Guide Tube
(x2)



Nozzle
Cleaning Kit
(x1)

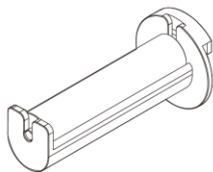

Filament Holder
(x4)



USB Storage



Fuse

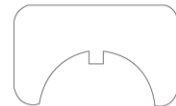

Filament Box Block
(x4)

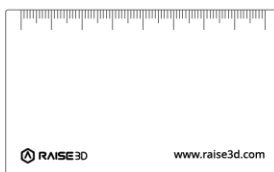

0.3 mm Feeler Gauge
(x1)



quick connector
(x2)

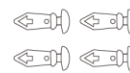

Plastic rivet
(x4)

Precaution and Hardware Installation

- **Read the entire installation section before starting installation**

WARNING

Connect equipment to a grounded facility power source. Do not defeat or bypass the ground lead.

- Know the location of equipment branch circuit interrupters or circuit breakers and how to turn them on and off in case of emergency.
- Know the location of fire extinguishers and how to use them. Use only ABC type extinguishers on electrical fires.
- Know local procedures for first aid and emergency assistance at the customer facility.
- Use adequate lighting for the equipment.
- Maintain the recommended range of temperature and humidity in the equipment area.
- Do not use this product in an environment containing volatile or flammable compounds.

- **Environmental requirements**

- E2 is for indoor use only.
- Excessive solids (conductive or non-conductive) in the air may cause system damage.
- The accumulation of oil in the air can damage the plastic parts of the printer.
- The operating temperature should be in the range of 15°C to 30°C, with a relative humidity range of 10% to 90% without condensation. The storage temperature shall be in the range of -25°C to 55°C, and the relative humidity range shall be 10% to 90% non-condensation.
- The altitude shall not exceed 2,000 meters.
- Noise (Acoustics) : <50dB(A) during printing

NOTE: E2 printers may generate vibrations which depend mainly on the geometry of parts being printed and material characteristics. This will need to be taken into account if locating the printer near vibration sensitive equipment. Please note that during transportation in low temperatures, there is a chance the machine may frost or freeze. The printer can resume use after being kept 4 - 6 hours in an area that is room temperature.

- **Input supply connection and grounding**

During installation, the main outlet socket should be protected according to appropriate rules. Check the input voltage, phase, and frequency supplied to this machine before turning it on. Verify the connection of grounding wires from the machine to the input source. The allowable input voltages are 1x (90-240)V 50Hz/60Hz. For more information about input supply refer to the technical specification section of this manual and to the rating plate of the machine. Make sure the amount of power available from the input connection is adequate for normal operation of the machine.

● **Hardware Installation and First Print**

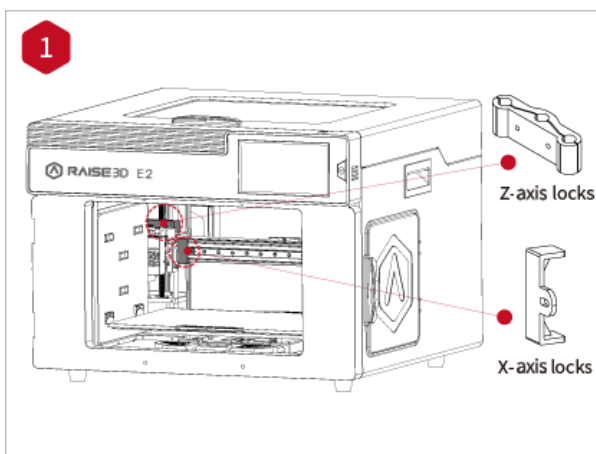

Use hands to remove the Z-axis and X-axis locks. Please carefully store the removed locks, so that they can be installed again and used in subsequent transportation.

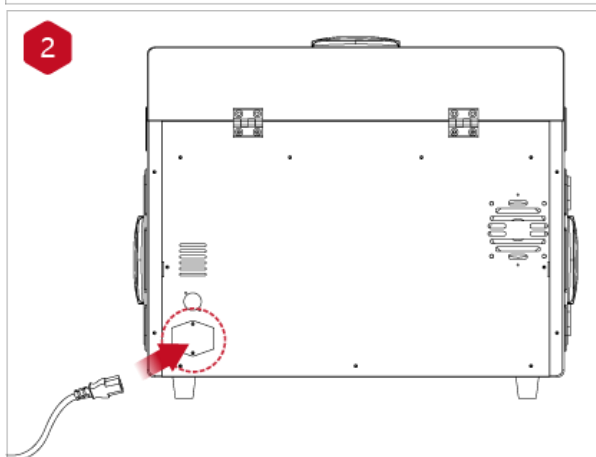

The top foam contains five power cords of different standards. Please use the power cord that conforms to your current country (or region) and connect it to the power socket. Turn on the switch and start the device.

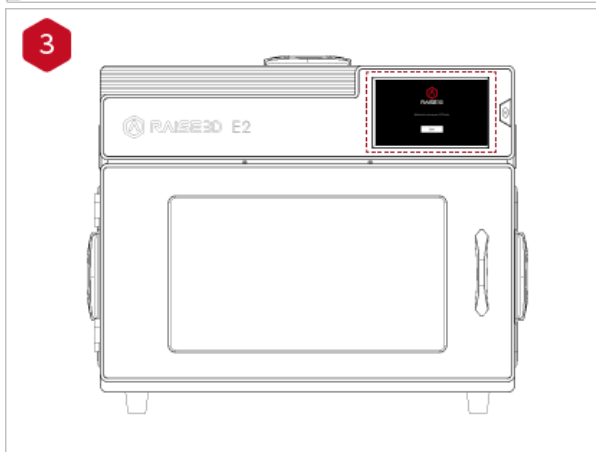

Turn on the power and the printer will enter the boot process. Your Raise3D printer will take about 60 seconds to boot. When the touch screen displays the "Welcome" window, the printer is ready. Then you can finish the installation and first print according to the Setup guide.

Software Installation

● ideaMaker Installation

The slicing software, ideaMaker, is available on the USB storage device included with your printer.

Additional downloads and versions are available online at:

<https://www.raise3d.com/download/>



- Open the installer and choose your preferred language. Select your preferred installation location for ideaMaker, and click "Next".

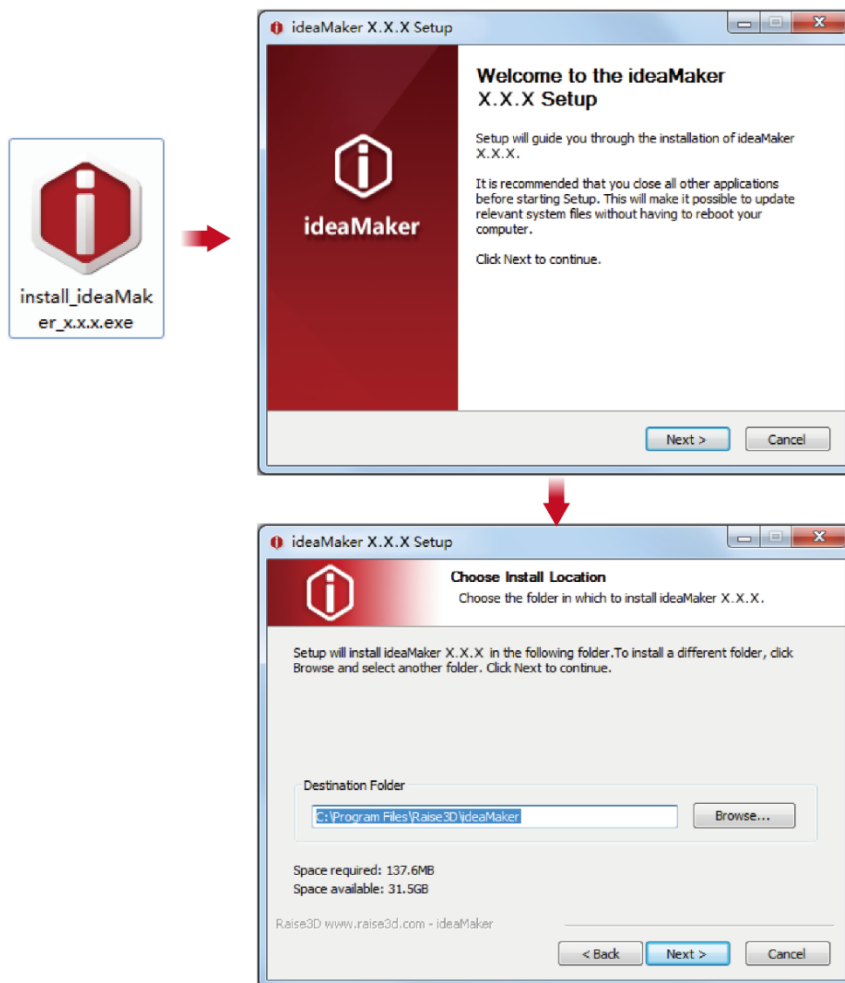

- Follow the instructions provided by the guide, and click "Install". After the installation is finished, click "Next" to go to the next step.

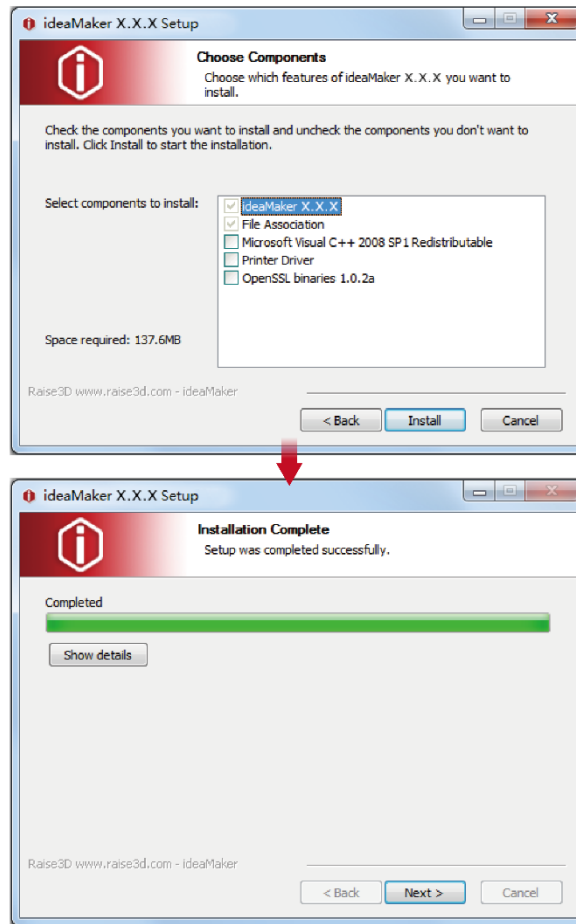

- Click "Finish" and ideaMaker is installed.



MAC OS X

Open the Disk Image for the ideaMaker installer. This is located in the USB storage device included with your printer. Alternatively, you can download the latest version from <https://www.raise3d.com/download/>. Next, drag the ideaMaker icon(left) into the Application folder on the right side.



- **ideaMaker Initial Settings**

- When launching ideaMaker for the first time, you will need to select your printer model. Select "printer setting" and choose the type of the printer you are using, then press "Next".

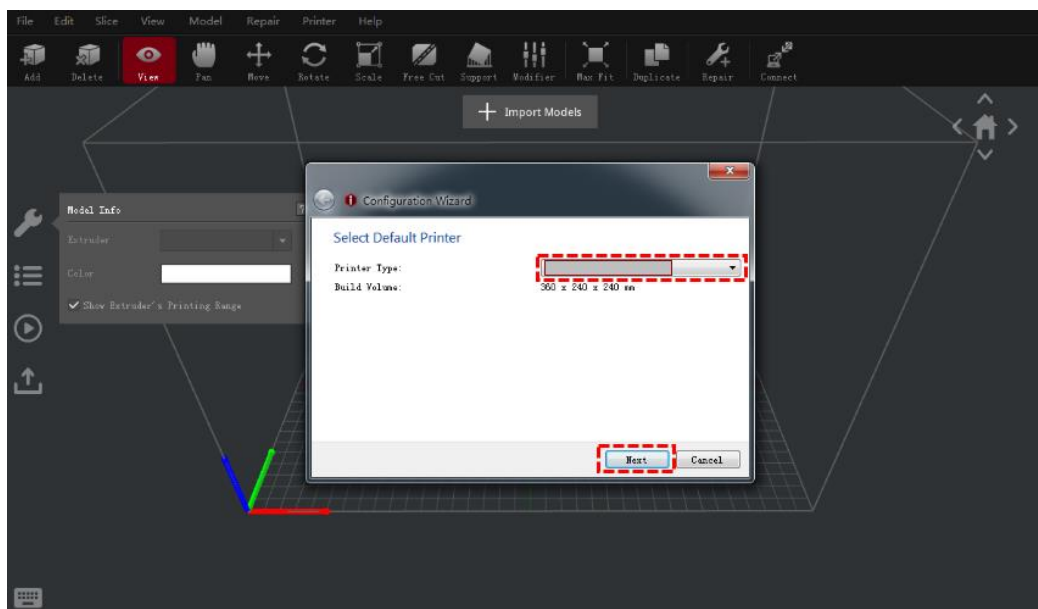

- Select the diameter of your filament. Press "Finish" to finalize the initial settings.

NOTE: ALL E2 printers use 1.75 mm filaments.

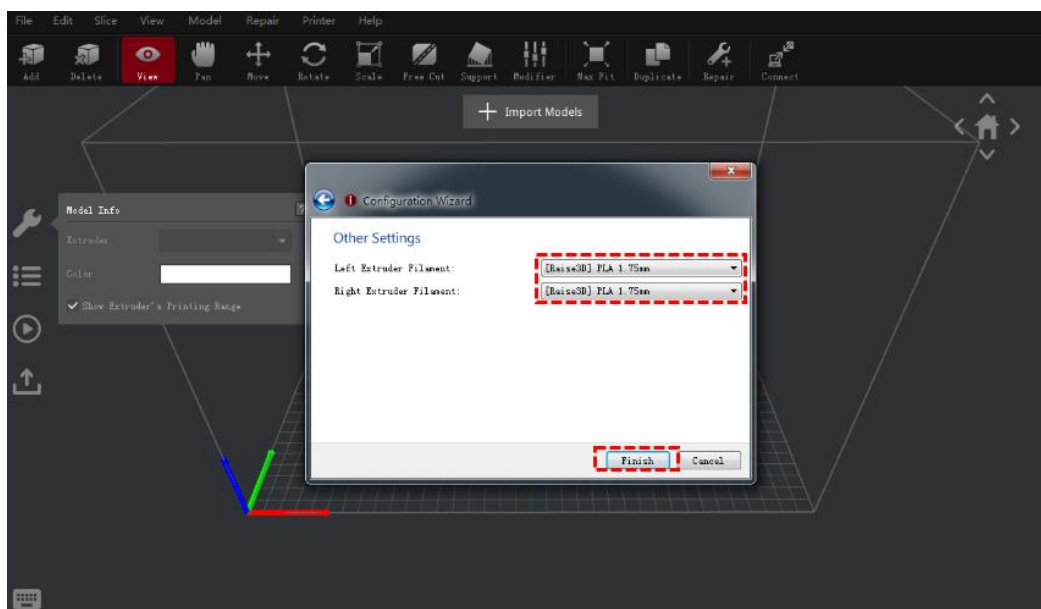

- **Using ideaMaker**

➤ Click the "+" button to import "Giveaway Spinner" included in the USB storage device.

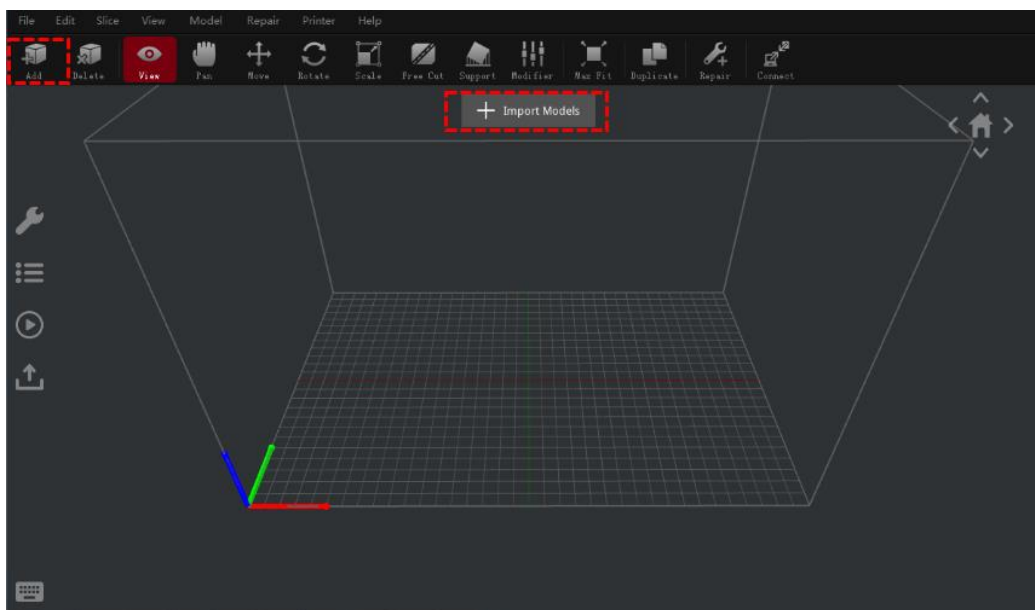

➤ Click the "Start" or "▶" button to begin slicing the model.

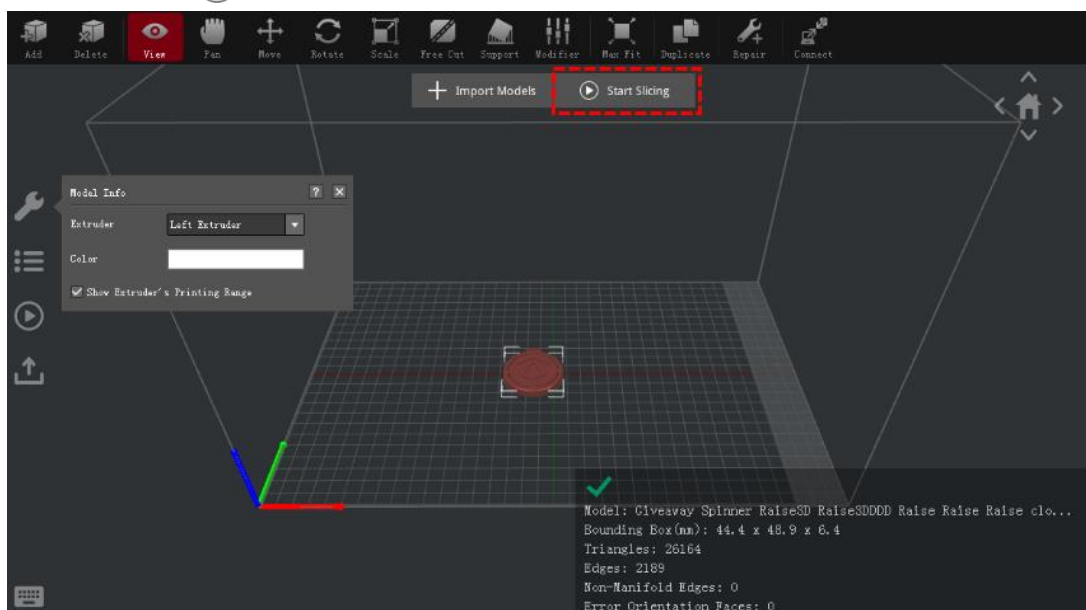

- Confirm your printer type and material are correct, then select the standard slicing template. Click "Edit" to select the type of Platform Addition and the type of Support.

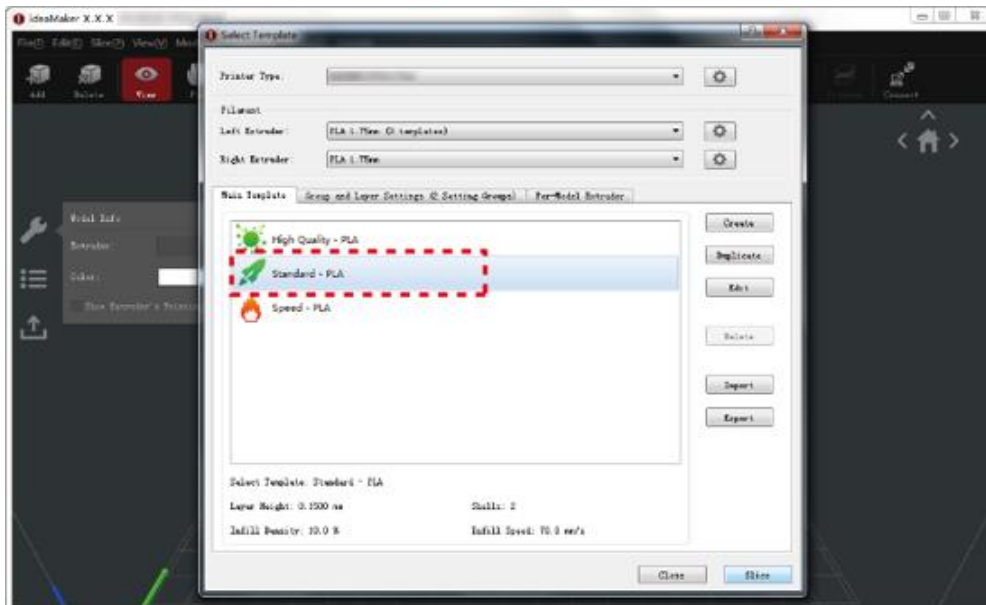

- Click "Save and Close" to return to the previous menu. Click "Slice" to generate your file.

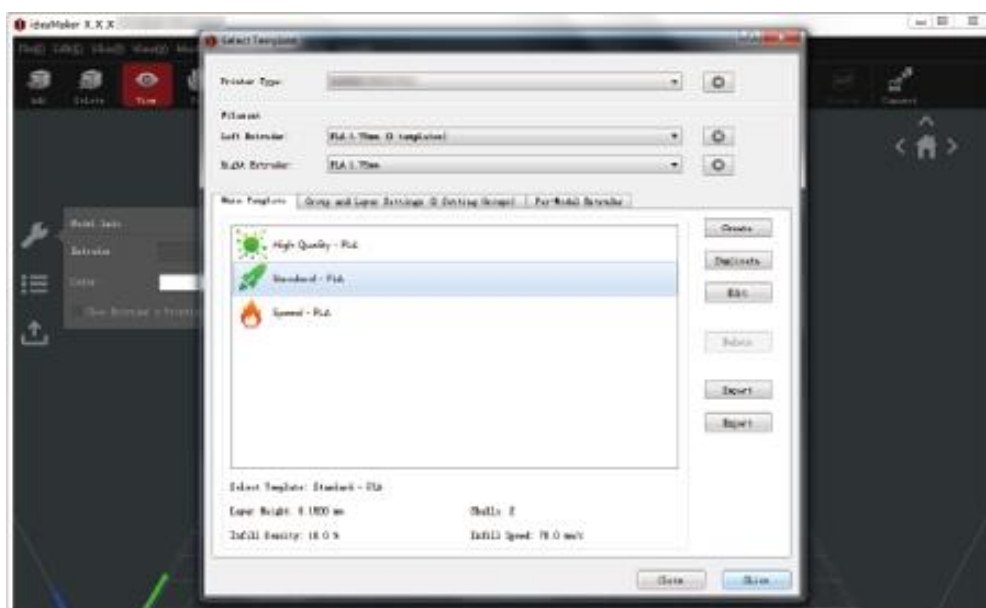
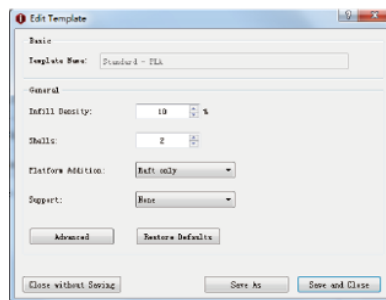

- Save the sliced files (.gcode and .data) by exporting them to the included USB storage device.
NOTE: File names that do not conform to the Western Latin character set may not display properly.

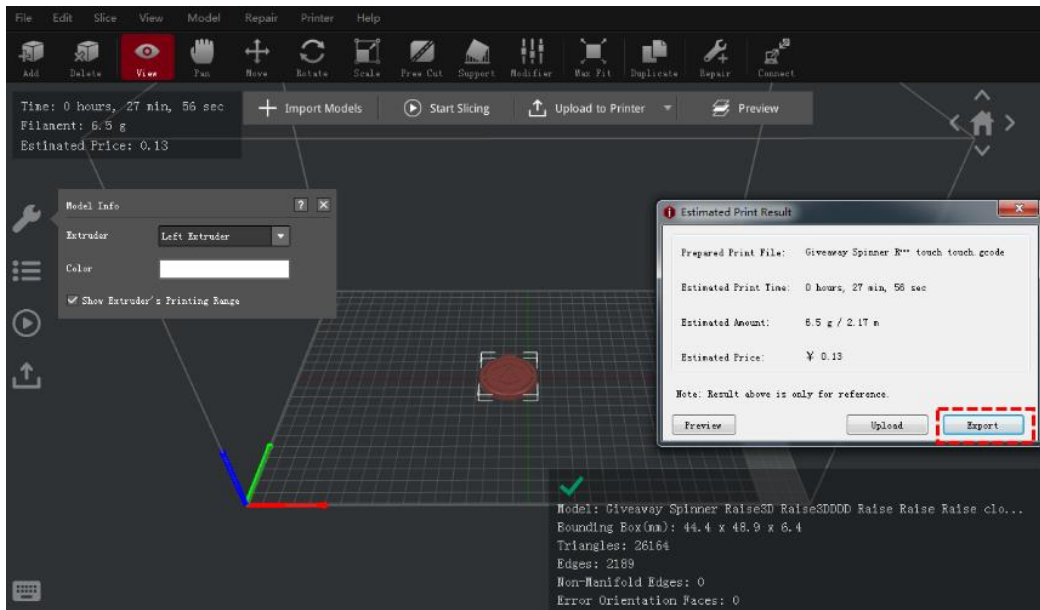

- Confirm that the files are saved and eject the USB storage device.



WLAN Connection

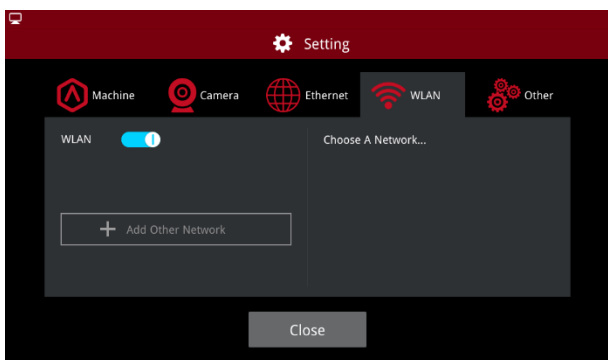

You can connect to a network by selecting the SSID and inputting the password. When the Wi-Fi module is manufactured, 2.4G is set at HT20, 5GHz is set at HT40.
Note: The Wi-Fi's frequency is fixed before being manufactured. The customer is not allowed to modify the Wi-Fi's parameters. (If needed, please contact our tech support team).

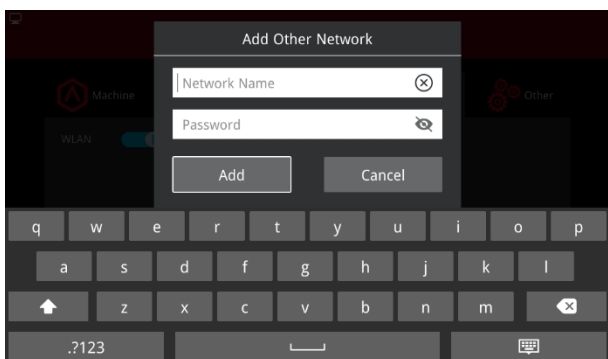

Alternatively, you can select "Add Other Network" and input a name and password.

Maintenance

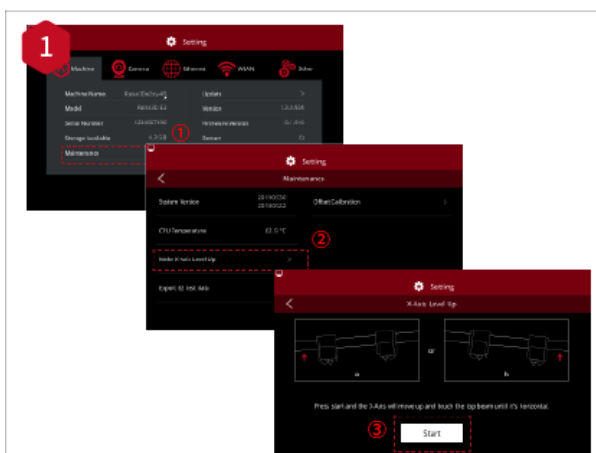

The printers are pre-leveled at the factory, but we recommend verifying that the leveling has not changed during shipping.

How to level up the X-axis:
As shown in figure 1, click "Maintenance" to level up the X-axis and it will touch the top beam until horizontal.

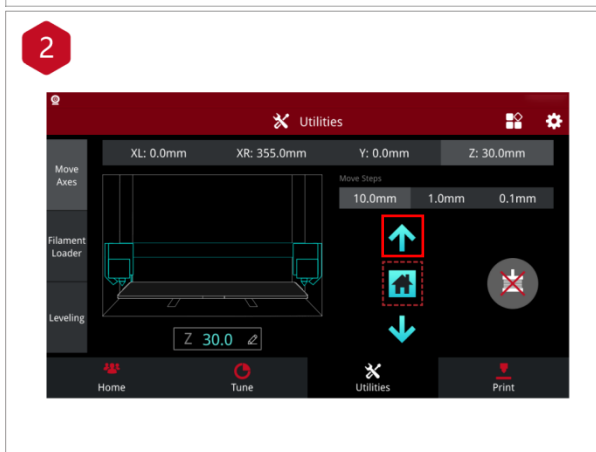

Click the "Utilities" menu and home the Z-axis. Press the upward arrow to lift the Z-axis about 0.3 mm-0.7 mm.

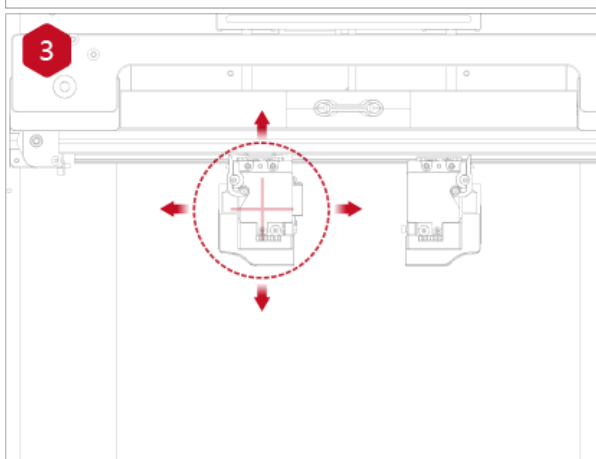

Check the distance between the nozzle and the printing platform. After pushing the left extruder to the center position on the platform, loosen the nozzle screw.

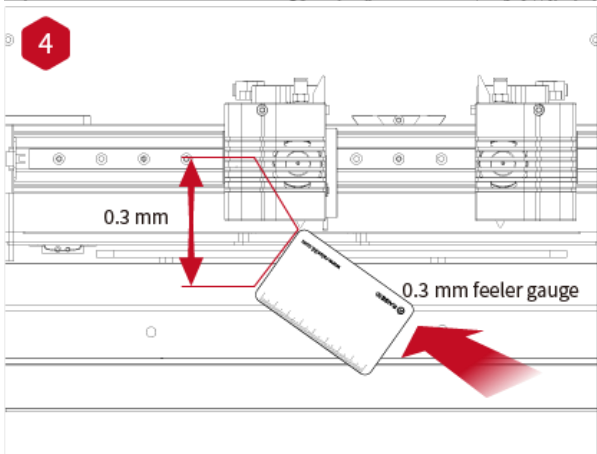
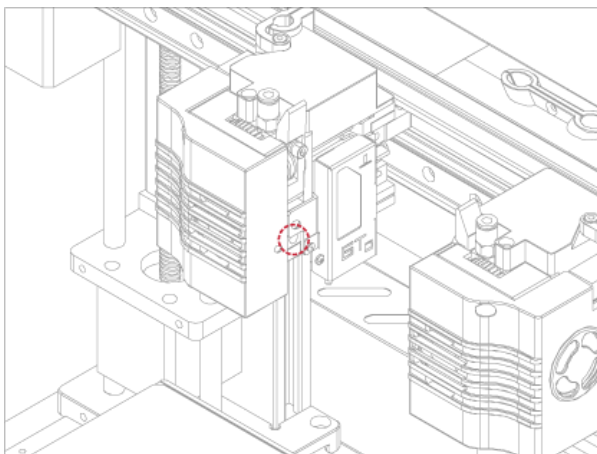

Take out the gauge from the Accessory Kit and insert it between the nozzle and the platform. Adjust the nozzle so that the distance between the nozzle and the printing platform exactly matches the thickness of the gauge (about 0.3 mm). Tighten the nozzle screw and remove the gauge. The other nozzle is adjusted in the same way.

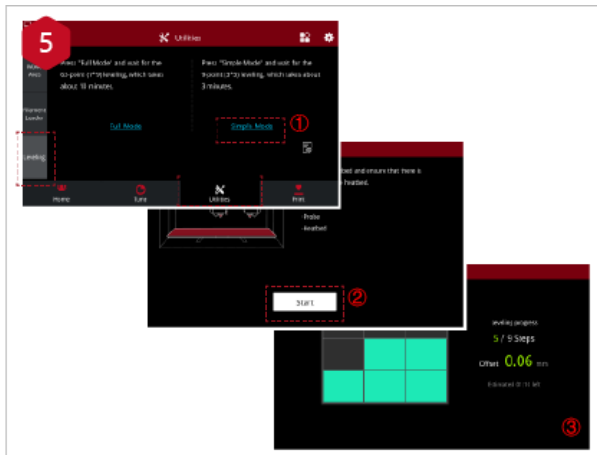

Follow the steps shown in the figure on the touch screen to run 9-point automatic leveling.

After the 9 grid interface automatically closes, the leveling is finished.

Start Printing

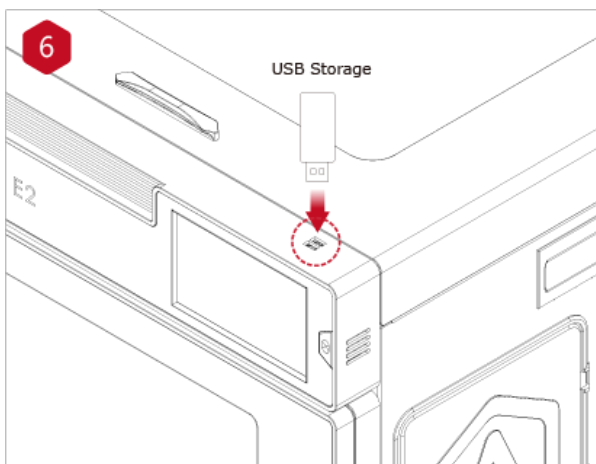

Insert the USB storage device into the USB slot on the side of the touch screen.

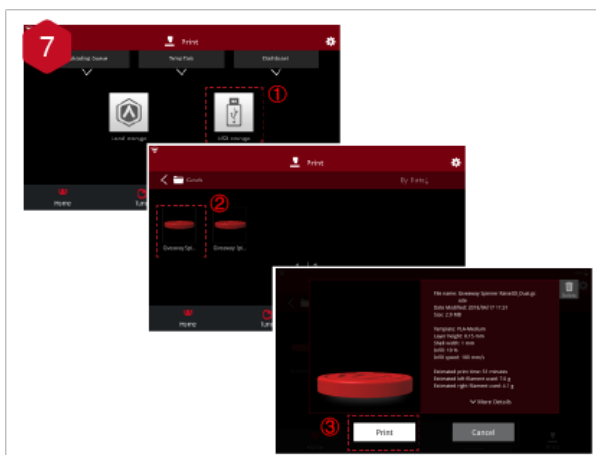

Select the "Print" tab, and choose "USB Storage". Select the file and check the printing parameters and settings. Press "Print" to start printing the test file.

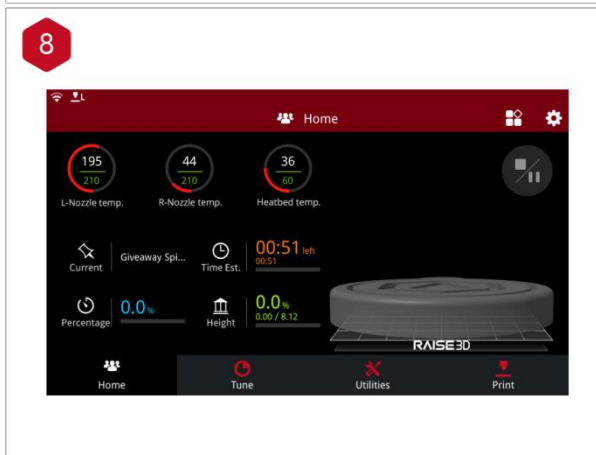

During printing, you can check the status of your printing, including printing time and other parameters, from the touch screen in the "Home" interface.

NOTE: The touch screen will display an image of your model on-screen during printing. This image will only be shown when the file is sliced by ideaMaker before being uploaded to the printer.

User Interface

Home

- Extruder and heated temperature
- Current model name
- Total print time
- Current print status
- Print height
- Status
- Menu and Settings button
- Pause, Resume and Stop button
- Visual display of the current model
- Taskbar

Tune

- Print parameters

Utilities

- Move the axis
- Loading/Unloading
- Leveling
- Visual display of X/Y/Z axes
- Coordinate value and Custom edit function
- Choose the X/Y/Z axes
- Move distance "Unit Settings"
- X/Y/Z axes move and return button
- Disable motor button

Print

- Upload, Resume Print Task, and Print Statistics
- The storage location of the printed file

Experiencing Difficulties/Contact Information

If you run into any issues during this guided setup, please contact our expert technicians by creating a ticket at support.raise3d.com. Customers outside of the US, please contact your local Raise3D distributor or reseller.

For sales information please contact us at sales@raise3d.com.

Other inquiries: for any other inquiry please send an email to inquiry@raise3d.com.





US Office

43 Tesla, Irvine, CA 92618, USA
+1 888 963 9028

Netherlands Office

Stationsplein 45 Unit A4.004 3013AK Rotterdam, the Netherlands

China Office

4th Floor B5, 1688 North Guoquan Road, Yangpu District, Shanghai 200438
400 6367 888 (For the Mainland of China only)

